

卫生级管支架系列
Sanitary Pipe holder Series

液位计 Liquidometer
3171011

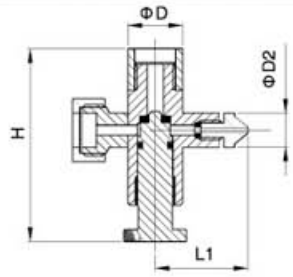

Size	H	D2	D	L1	kg
1"	110.0	22.0	27.2	61.0	
1 1/2"					
2"					
2 1/2"					
3"					
4"					

管支架 Pipe holder
3181012

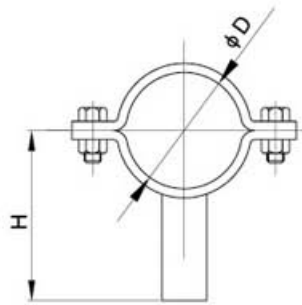

Size	H	D	kg
1"	61.0	25.4	
1 1/4"	64.0	31.8	
1 1/2"	67.0	38.1	
2"	74.0	50.8	
2 1/2"	80.0	63.5	
3"	86.0	76.2	
3 1/2"	93.0	89.0	
4"	100.0	101.6	
4 1/4"	102.0	108.0	
4 1/2"	105.0	114.0	
5"	115.0	133.0	
6"	128.0	159.0	

六角型管支架 Hexagon pipe holder
3180013

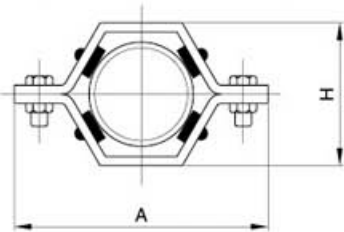

Size	A	H	kg
1"	87.0	36.8	
1 1/2"	101.6	53.9	
2"	114.3	63.5	
2 1/2"	120.6	79.4	
3"	139.7	95.2	
4"	171.4	120.6	

六角型管支架 Hexagon pipe holder
3180014

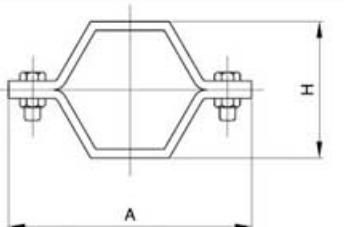

Size	A	H	kg
1"	87.0	36.8	
1 1/2"	101.6	53.9	
2"	114.3	63.5	
2 1/2"	120.6	79.4	
3"	139.7	95.2	
4"	171.4	120.6	

卫生级管支架系列
Sanitary Pipe holder Series

六角型管支架 Hexagon pipe holder
3180015

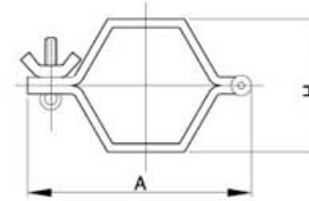

Size	A	H	kg
1"	87.0	36.8	
1 1/2"	101.6	53.9	
2"	114.3	63.5	
2 1/2"	120.6	79.4	
3"	139.7	95.2	
4"	171.4	120.6	

圆型管支架带柄 Round pipe holder with handle
3181016

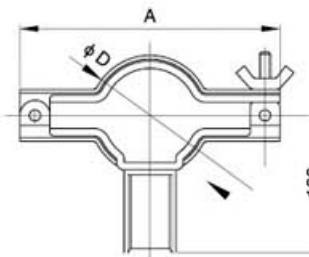

Size	A	D	kg
1"	66.0	25.4	
1 1/2"	76.0	38.1	
2"	90.0	50.6	
2 1/2"	105.0	63.5	
3"	120.0	76.3	
4"	146.0	101.6	

六角型管支架带柄 Hexagon pipe holder with handle
3181017

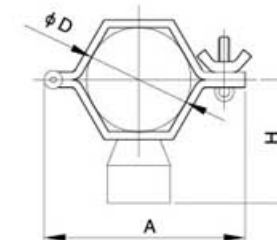

Size	A	D	H	kg
1"	61.0	25.0	45.0	
1 1/2"	76.0	38.0	51.5	
2"	90.0	51.0	58.0	
2 1/2"	106.0	63.5	64.0	
3"	120.0	76.0	70.5	
4"	146.0	101.6	83.0	

六角型管支架带柄 Hexagon pipe holder with handle
3181018

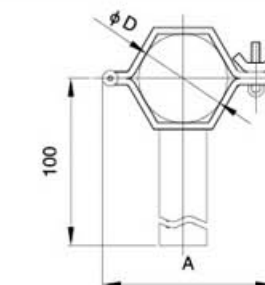

Size	A	D	kg
1"	61.0	25.0	
1 1/2"	76.0	38.0	
2"	90.0	51.0	
2 1/2"	106.0	63.5	
3"	120.0	76.0	
4"	146.0	101.6	